

PHONIC

Sound Ambassador 35 Deluxe

Wireless Portable Sound System

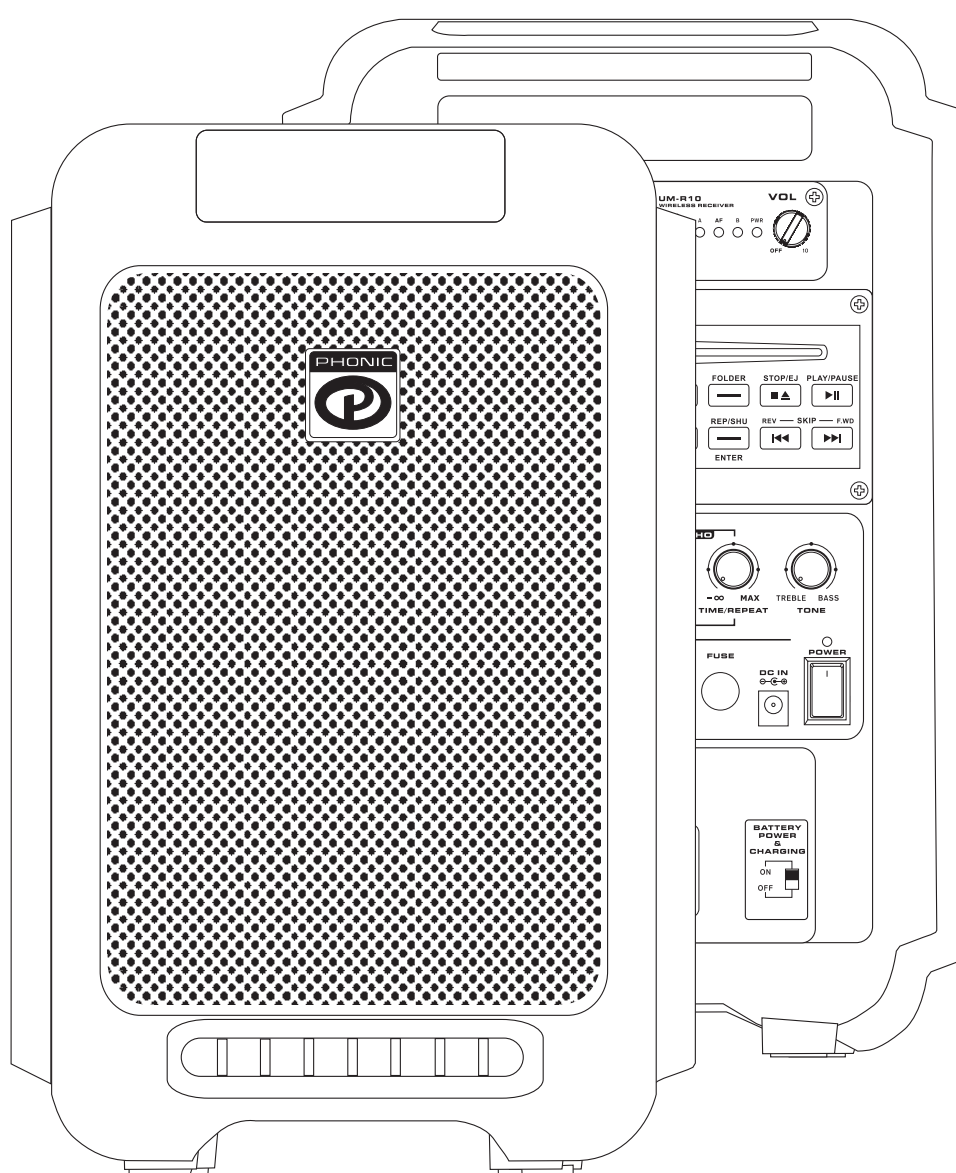

English

User's Manual

IMPORTANT SAFETY INSTRUCTIONS

The apparatus shall not be exposed to dripping or splashing and that no objects filled with liquids, such as vases, shall be placed on the apparatus. The MAINS plug is used as the disconnect device, the disconnect device shall remain readily operable.

Warning: the user shall not place this apparatus in the confined area during the operation so that the mains switch can be easily accessible.

1. Read these instructions before operating this apparatus.
2. Keep these instructions for future reference.
3. Heed all warnings to ensure safe operation.
4. Follow all instructions provided in this document.
5. Do not use this apparatus near water or in locations where condensation may occur.
6. Clean only with dry cloth. Do not use aerosol or liquid cleaners. Unplug this apparatus before cleaning.
7. Do not block any of the ventilation openings. Install in accordance with the manufacturer's instructions.
8. Do not install near any heat sources such as radiators, heat registers, stoves, or other apparatus (including amplifiers) that produce heat.
9. Do not defeat the safety purpose of the polarized or grounding-type plug. A polarized plug has two blades with one wider than the other. A grounding type plug has two blades and a third grounding prong. The wide blade or the third prong is provided for your safety. If the provided plug does not fit into your outlet, consult an electrician for replacement of the obsolete outlet.
10. Protect the power cord from being walked on or pinched particularly at plug, convenience receptacles, and the point where they exit from the apparatus.
11. Only use attachments/accessories specified by the manufacturer.
12. Use only with a cart, stand, tripod, bracket, or table specified by the manufacturer, or sold with the apparatus. When a cart is used, use caution when moving the cart/apparatus combination to avoid injury from tip-over.
13. Unplug this apparatus during lightning storms or when unused for long periods of time.
14. Refer all servicing to qualified service personnel. Servicing is required when the apparatus has been damaged in any way, such as power-supply cord or plug is damaged, liquid has been spilled or objects have fallen into the apparatus, the apparatus has been exposed to rain or moisture, does not operate normally, or has been dropped.

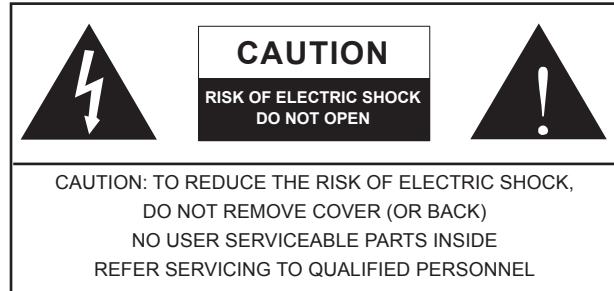

The lightning flash with arrowhead symbol, within an equilateral triangle, is intended to alert the user to the presence of uninsulated "dangerous voltage" within the product's enclosure that may be of sufficient magnitude to constitute a risk of electric shock to persons.



The exclamation point within an equilateral triangle is intended to alert the user to the presence of important operating and maintenance (servicing) instructions in the literature accompanying the appliance.

WARNING: To reduce the risk of fire or electric shock, do not expose this apparatus to rain or moisture.

CAUTION: Use of controls or adjustments or performance of procedures other than those specified may result in hazardous radiation exposure.



Sound Ambassador 35 Deluxe

Wireless Portable Sound System

USER'S MANUAL

TABLE OF CONTENTS

INTRODUCTION.....	4
FEATURES.....	4
OPTIONAL ACCESSORIES.....	5
BASIC SETUP.....	5
PRODUCT OVERVIEW.....	6
WIRELESS MICROPHONE RECEIVER.....	8
CD PLAYER.....	8
MP3 RECORDER.....	9
IMPORTANT INSTRUCTIONS.....	11
OTHER IMPORTANT FEATURES.....	12
OPERATING HINTS.....	13
APPLICATION.....	14
SPECIFICATIONS.....	15
DIMENSIONS.....	16
BLOCK DIAGRAM.....	17

INTRODUCTION

We at Phonic would like to congratulate you on your purchase of our Sound Ambassador 35 Deluxe wireless portable sound system. This extremely stylish system will allow you to carry all the gear you need to set up a moderate front of house sound system anywhere you go without lugging around chunky mixers, speakers and cords.

Including microphone and line inputs, the Sound Ambassador 35 Deluxe provides enough for a solo performer, DJ or other small-scale performer to give their audience crystal clear sound. The Sound Ambassador can be further customized to include wireless microphones (UHF or infrared) and a CD player with MP3 playback or MP3 recorder/player, further adding to the versatility of these great units. The built-in amplifier pumps 35 Watts of power through the 6.5" speaker – all of which is built right into the cabinet!

This owner's manual was designed to give you a clear picture of all the features and functions of the Sound Ambassador 35 Deluxe. It is strongly advised that you read this manual carefully before storing it in an easily accessible for future reference.

FEATURES

- All-in-one compact mobile wireless sound system
- 6.5" full range speaker and 35 watts power amplifier built-in
- Optional UHF or Infrared wireless microphones
- Optional CD player with anti-shock and MP3 playback or MP3 recorder/player
- Built-in DC charging circuit
- 12 VDC supply from built-in, maintenance-free lead acid type rechargeable batteries, 2.7Ah
- DC inlet for external power supply
- Slot for choice of two UHF PLL synthesized diversity or Infrared wireless receiver modules
- Built-in diversity receiving antennas
- One 1/4" phone jack for wired microphone input
- 1/4" phone jack jacks for line-level input and output
- Built-in limiter and protection circuitry to minimize distortion and overload
- Individual volume control for wired and wireless microphones
- Echo effect with level and time/repeat controls
- 25mm diameter tripod stand adapter included

MODEL LIST

SA35D-UM30-D includes the UM30 wireless handheld mic, CD player with MP3 playback and 12V/2.7A rechargeable battery.

SA35D-UM30-2-D includes two UM30 handheld wireless mic, CD player with MP3 playback and 12V/2.7A rechargeable battery.

SA35D-UM40-D includes the UM40 wireless lavalier mic, CD player with MP3 playback and 12V/2.7A rechargeable battery.

SA35D-UM30-M includes the UM30 wireless handheld mic, MP3 recorder/player and 12V/2.7A rechargeable battery.

OPTIONAL ACCESSORIES

- UM30: 16 channel UHF Wireless Handheld Microphone System, includes 1 x HT-100 handheld microphone with built-in transmitter and 1 x UM-R10 UHF receiver
- UM40: 16 channel UHF Wireless Lavalier Microphone System, includes 1 x BT-200 bodypack transmitter, 1x ML-10 microphone and 1x UM-R10 receiver
- UM50: 16 channel UHF Wireless Headset Microphone System, includes 1 x BT-200 bodypack transmitter, 1x MH-20 microphone and 1x UM-R10 receiver
- Infrared wireless microphone
- CD Player with MP3 playback
- MP3 recorder/player
- Carry bag
- S3 tripod stand
- Wired microphone

BASIC SETUP

1. Ensure all power is turned off on the Sound Ambassador Deluxe.
2. All level controls should be set at the lowest level to ensure no sound is inadvertently sent through the outputs when the device is switched on. All levels can be adjusted to acceptable degrees after the device is turned on.
3. Plug all necessary instruments and/or equipment into the Sound Ambassador's various inputs as required.
4. Though it is not required (as the Sound Ambassador Deluxe's speaker is built-in), you may wish to connect another device to the Sound Ambassador Deluxe's line output, which could further enhance your set up.
5. Plug the supplied DC power supply into an appropriate AC power socket, and the DC head of the power supply into the DC power socket of the Sound Ambassador 35 Deluxe. This is, of course, not really vital as the Sound Ambassador Deluxe has an internal battery.
6. Turn the power switch on, and you should be ready to go.

PRODUCT OVERVIEW

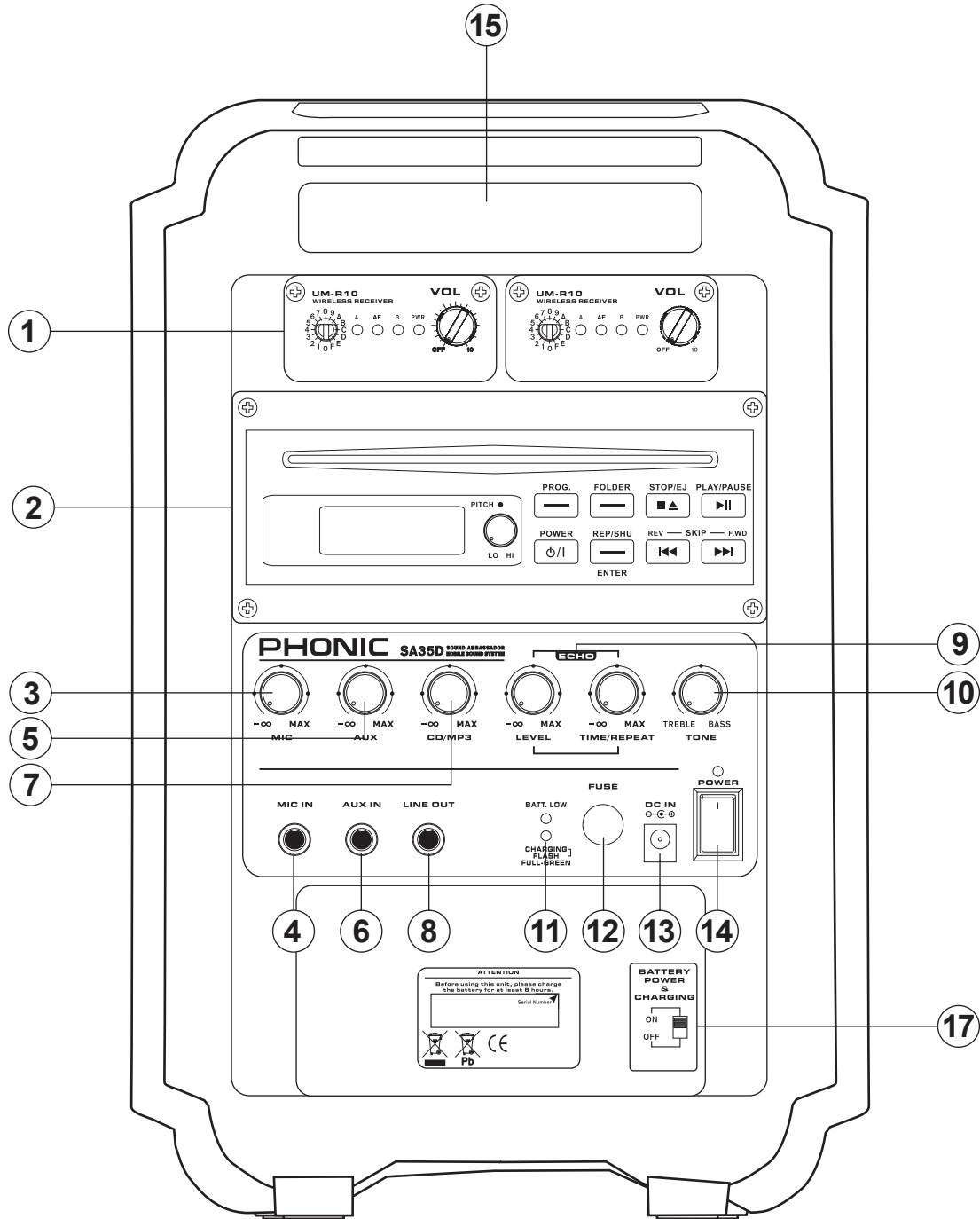

1. Wireless Microphone Module Slots

These two slots are for the addition of wireless microphone modules to your Sound Ambassador. They allow users to use microphones from various locations without a cord getting in the way. For information on purchasing the wireless microphone kit, please contact your nearest Phonic dealer.

Please Note: The wireless modules act as their own, individual channel, with its own volume control – the signal of which is sent to the main mix.

2. CD Player / MP3 Recorder Module Slot

This slot is for the addition of an optional Compact Disc player or MP3 recorder/player to the Sound Ambassador 35 Deluxe. By adding the CD player users are able to feed the audio from CDs to the built-in mixer; the MP3 recorder/player allows users to record the audio received by their Sound Ambassador.

3. Mic Level Control

This controls the level of the 1/4" microphone input, allowing users to adjust the level of the audio that is sent to the main mix.

4. Microphone Input

This 1/4" Phone Jack is for the addition of high impedance microphone to the Sound Ambassador Deluxe.

5. AUX Level Control

This controls the level of the 1/4" auxiliary input, allowing users to adjust the level of the audio that is sent to the main mix.

6. AUX Input

This input accepts typical 1/4" TS inputs for unbalanced signals, best suited for input of all kinds of gear, including electric guitars, bass guitars, keyboards, or even other Sound Ambassador units.

7. CD/MP3 Level Control

This controls the level of audio that is received by the optional CD player or MP3 recorder. Turning the control all the way to the left will affectively mute the CD player or MP3 recorder.

8. Line Outputs

This 1/4" output sends the main signal of the Sound Ambassador Deluxe to external devices. Users are able to send the signal to other sound systems, allowing the signal to be incorporated in other mixes, or to an amplifier, allowing other speakers to output the signal in addition to the built-in speaker, as well as link to other Sound Ambassadors Deluxe.

9. Echo Effect

These two controls adjust the different properties of the built-in echo effect. The level control allows users to determine the amount of the microphone (both wired and wireless) signal will be affected by the echo effect, and the time/repeat control adjusts the intensity of both the time and repeat parameters. Turning the level control to the ∞ position affectively mutes the effect.

10. Tone Control

This control allows users to adjust the high and low frequency sounds of the main signal; turning the control to the left will add more treble to their audio, whereas turning it to the right will increase the bass. Keeping it perfectly centered will affectively disable the tone function.

11. Power Indicators

The LED indicators just to the left of the fuse holder allow users to see the status of the battery. The uppermost indicator, Batt. Low, illuminates red when the battery power is low and needs to be charged. When at full capacity, the lower LED will illuminate green. This same indicator will flash red when the unit's built-in battery is in the process of charging. When the battery level is low, the Power LED will flash for a few minutes before shutting the device down. Depending on the volume of the unit, it may last for longer in low battery mode.

12. Fuse Holder

If for some reason the Sound Ambassador 35 Deluxe's fuse blows, use a coin to unscrew the fuse holder and replace with another appropriate fuse.

13. DC Power Input

This inlet is for the connection of a DC power source, allowing power to be supplied to the unit. Please use the DC power supply provided along with this unit only, as using another supply could damage the unit and void any warranty.

14. Power Switch and Indicator

Flicking this switch turns the Sound Ambassador on and off. If no external power source is connected to the device, power will be supplied by the built-in battery. When the power is turned on, the blue Power LED will illuminate.

15. Handle

This feature was provided to allow users to carry the Sound Ambassador 35 Deluxe much more easily.

16. IR Receiver

This unit comes with the Infrared receiver already installed if bought with the infrared microphone kit.

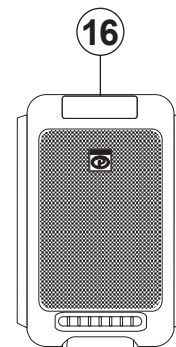

17. Battery Power and Charging Switch

When this switch is set to ON, the Sound Ambassador Deluxe's internal battery can be either charged or used to power the unit. If it's set to OFF, the battery is effectively cut off from the rest of the unit. Users are advised to set this switch to OFF if the Sound Ambassador will be without operation for an extended period of time.

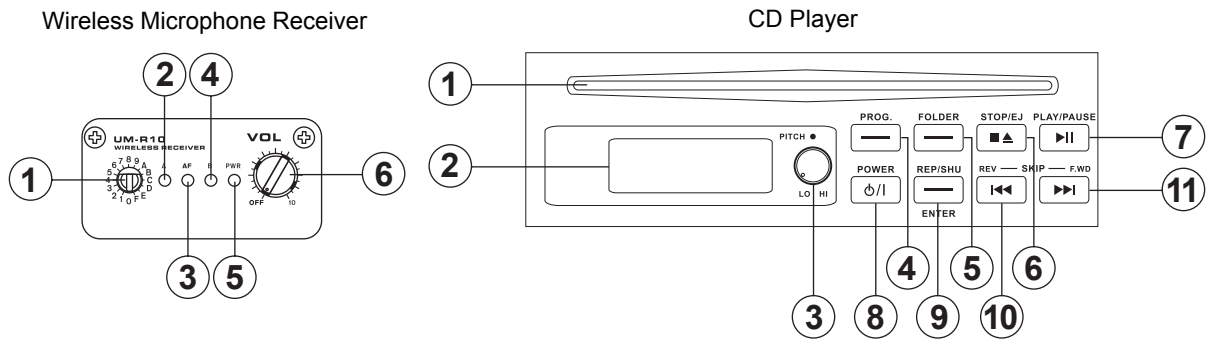

Wireless Microphone Receiver

1. Frequency Select – Use this to select the frequency at which the wireless module will receive signals. The wireless microphone should be set to the same frequency.
2. A Indicator – Depending which antennae is being used, either the A or B indicators will illuminate.
3. AF Indicator – AF Indicator - This will illuminate when a wireless microphone audio signal is received.
4. B Indicator – Depending which antennae is being used, either the A or B indicators will illuminate.
5. PWR Indicator – When the volume control is not in the off position, this LED will light up.
6. Volume Control – The volume of the microphone signal can be adjusted using this. Turning this control all the way to the left will effectively turn the wireless microphone module off.

Information on the Infrared Microphone was unavailable at the time of this publication. For information on this unit, please visit www.phonic.com.

For more information on the usage and operation of the UM Wireless microphone sets, please consult their individual operation manuals.

CD Player

1. CD Slot – Insert your CD here. Ensure the CD's label is facing upwards. This CD player accepts 12cm CDs.
2. Digital Display – View the track number and elapsed time here.
3. Pitch Control – Turn this control to increase and decrease the tempo of your audio from the audio or MP3 CD. Turn the control to the left to slow the music down, turn it to the right to speed it up.
4. Program – Press the 'PROG' button and use the FWD and REV buttons to select tracks. Press 'REP/SHUF-ENTER' to record your selected tracks. If you wish to add more tracks, repeat the procedure above. 'PLAY/PAUSE' will confirm and play the tracks.
5. Folder – When playing an MP3 CD, pushing this button will allow you to use the Forwards and Reverse buttons to skip through the next folders / directories.
6. Stop/Eject – When a CD is loaded, press this button to stop the audio from playing. Press it again to remove the CD.
7. Pause/Play – Push this button to play or pause the selected track.
8. Power – Push this button to turn the CD player on. Make sure the CD/MP3 control is not in the off position.
9. Repeat/Shuffle – When a CD is inserted, it will automatically play with repeat mode active. Pushing this button allows the CD player to play tracks at random, and pushing it again will turn repeat mode back on.
10. Reverse – Push this button to go back through the tracks. Hold it down to rewind an individual track.
11. Forwards – Pushing this button skips forward through the tracks. Holding it down will allow you to skip forward through an individual track.

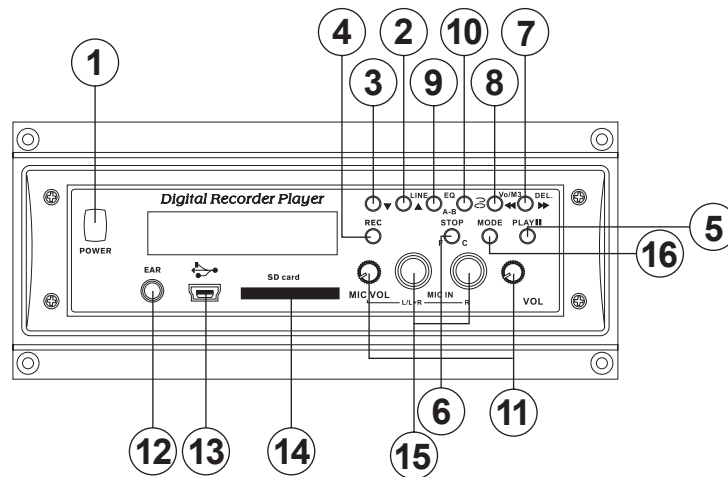

MP3 Recorder and Player

1. Power key – Push to turn the digital recorder on and off.

2. Up key – When wanting to select a track, push this button to scroll through the tracks in ascending order. Hold it down for two seconds to run through the track numbers faster (this function will not work in MP3 mode).

3. Down key – When wanting to select a track, push this button to scroll through the tracks in descending order. Hold it down for two seconds to run through the track numbers faster (this function will not work in MP3 mode).

4. Record key – Select track number when in VOC mode and push REC key to record on the current track. Push the stop button to stop recording. If the track you want to record on is already used, the LCD will show “≡≡” and you must delete the content of the track before recording. When the in-built memory only has 30 seconds left, the LCD will start to count down the remaining time. You can use a microphone, a line in audio source or a mixture of both as your recording source.

Note: If you want to record to an SD card or Flash memory, you must push Mode and stop button together to switch from C to F (as indicated in front of the time).

5. Play/Pause key – Select the track you want to play then push this key to play. Push this key again during play to pause the track.

6. Stop key – Push the key to stop all functions, for example recording, play back, track selection, etc.

7. Forward key – Pushing this key will skip forward through the track currently playing. The track will resume as normal when the key is released.

8. Rewind key – Pushing this key will rewind through the track currently playing. The track will resume as normal when the key is released.

9. A-B repeat key – While playing, push this key to indicate any point as start point (A point) and push again to indicate a finish point (B point). The device will repeat from A to B point until you push the key again to release the function and continue to play.

10. Repeat key – When playing in MP3 mode, push this key once to simply repeat a single track. Press repeat a second time to repeat all tracks. Push the key at the third time to release repeat function. This function can not be used in VOC mode.

11. Volume controls – There are two main volume controls. The Mic input controls the microphone input level, whereas the remaining volume control adjusts the output level.

This device offers the following inputs/outputs:

12. Earphone jack – for connecting headphones

13. USB – for connecting to a PC

14. SD card – for an SD memory card up to 1 GB

(When a 512 MB SD card is used, the recording time available is over 8 hours.)

15. Microphone – Connect up to two microphones. If only one microphone is used, use the left input.

16. Mode Key – Push the MODE key together with another key for special function selections. The LCD will show “MODE” when pushed. If you do not push another function key within 5 seconds, the machine will return to idle mode. The following are the details of special function keys.

1. **MODE + Up:** LCD will show “LINE IN”, and select line in audio source as recording source.
2. **MODE + A-B:** allows you to use different EQ presents. EQ functions will arrive in the following sequence: Normal, Classic, Pop, Rock, Jazz.
3. **MODE + Rewind:** Use this select VOC mode (allowing you to record from microphone or LINE IN source) or MP3 mode (allowing you to download mp3 files from PC).
4. **MODE + Forward:** When these two keys are pushed, the LCD will show “DEL.” Push Forward (ie. Del) key again to delete the track. The LCD will show “DEL” until the delete process is finished.
5. **MODE + Stop:** Change between the flash and SD card when in play or idle mode.

MP3 Player’s USB Connection

You can easily copy MP3 files from computer to the machine through USB connection. Connect the machine to your computer with an appropriate USB cable. Your computer will recognize a new removable storage device automatically. You can now add, delete, copy and preview files. If using Windows 98 or below a USB driver will need to be installed.

When connecting to a PC through the USB port, the computer will take the device as two removable disks (the first disk being the built-in flash memory, the second disk is the SD card). You can start to copy music from the computer to either of these discs, or copy any of your previously recorded files from the device to computer. As the recorded files from the device has been compressed to MP3 format, it is easy to playback the files without any re-encoding.

The device will playback the MP3 files you download from computer in MP3 mode and playback any sound files you recorded from the Mic or Line inputs in the VOC mode. However, the play sequence of the music files in MP3 mode is decided by the sequence the music was copied to the SD card, thus is not fixed. If you want MP3 music to play in a fixed sequence – or playback in VOC mode – you will need to change the file name of the MP3 files to M_INT.xx.MP3 (where “xx” is the track number you wish to store the file as) for on the built-in flash memory, or M_EXT_xx.MP3 (where “xx” is the track number you wish to store the file as) for use on an SD card. The file format must be MP3 for this to work.

IMPORTANT INSTRUCTIONS

- Turn the power off when you do not use this unit for a period of time.
- In order to keep stable data transmission, please do not twist, pull or manipulate the USB cord.
- Do not remove the USB cable during data transmission.
- Make sure the USB is safely 'removed' on your computer before you unplug the USB cable from the machine or computer.
- Do not apply excessive pressure to the LCD monitor or touch it with fingers or sharp instruments.
- Make every effort to ensure this unit does not get wet.
- Do not take SD cards out while data is being transmitted.
- Do not bend, strike, drop or take apart SD cards.
- Do not place the SD card in areas of high temperature, high humidity, dusty place, or an area with static electricity or other electrical field.
- Please ensure the SD card has been formatted before use.
- Make sure the write protection switch of the SD card is released before attempting to record.
- Our product will transmit large amounts of data while recording and playing. We strongly suggest using a high quality, high speed SD card as your extension memory card.
- We have extensively tested and approve of the following SD cards for use with this devices:

Toshiba SD-M51225R2W 512MB / Apacer SD 120X 1GB / Apacer SD 256MB
- We do not guarantee the function, operation, or life of any SD card as used in this device.
- We do not also take any responsibility for the damage of SD cards used within this device.
- Like all other digital products, users must back up their files from time to time. We do not take responsibility for any documents lost while an SD card is used within this device.

Other Important Features

Built-in Battery

The Sound Ambassador 35 Deluxe features a built-in maintenance-free lead acid type rechargeable battery, which provides 12V of direct current to the unit. When fully charged, the battery can run up to 2 to 4 hours. To remove the battery, simply push down on the two clips at the top of the battery cover and remove.

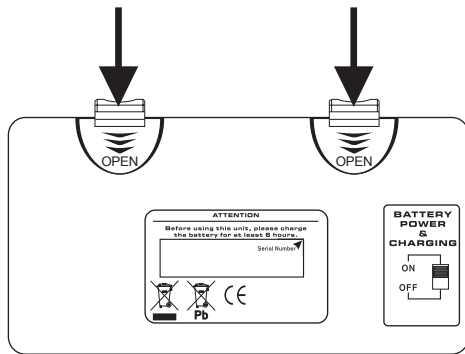

Tripod Stand Socket

Flip the Sound Ambassador 35 Deluxe over. On the bottom, you will find a hole, ideal for use with the Phonic S3 tripod stands (25mm in diameter).

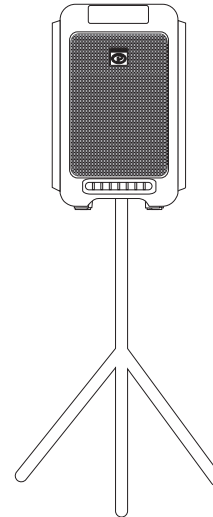

OPERATING HINTS

- 1.** Before or after use of this unit, users should charge the battery for approximately 8 hours. The battery pack loses charge while in storage, so it's important to charge the unit before storing, and do so every 3 months while the unit is being stored.
- 2.** If the battery remains uncharged for long periods of time, permanent damage could be caused and the battery will no longer be covered by warranty.
- 3.** If you use battery power, there is no need to connect to the unit's DC power source. The Sound Ambassador 35 Deluxe can last for 2 - 4 hours on battery power.
- 4.** You can run the unit on DC power and charge the internal battery simultaneously.
- 5.** If the power LED flashes, connect the DC power supply as soon as possible, as the battery is low and the unit will soon shut down.
- 6.** Before you turn the Sound Ambassador on, turn all volume controls to a minimum. Set them to an appropriate level after turning the unit on.
- 7.** Each sound source can be used simultaneously, and each source's volume is controlled independently.
- 8.** If you use the MP3 recorder/playback unit, you can use the system and record simultaneously.
- 9.** Please refer to the operating manual for any wireless microphones you may use for any safety and usage information in regards to these modules.
- 10.** Avoid pointing any microphone towards the speaker, as this will cause feedback.
- 11.** When the operating life of the battery becomes shorter, the battery is old and should thus be replaced. In normal operation, the battery should have a life of about 1 year, and is covered by warranty with consideration to any conditions that may apply.

PHONIC

APPLICATION

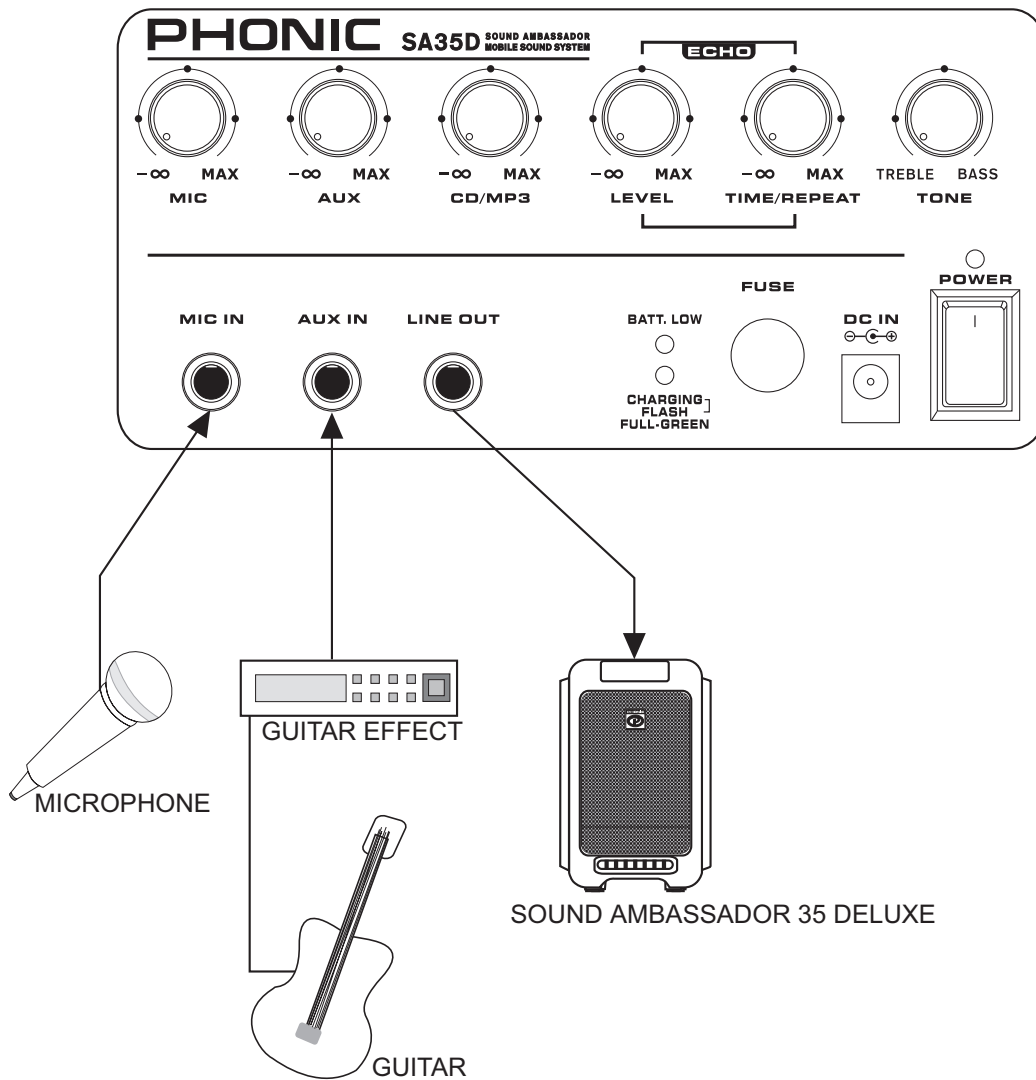

SPECIFICATIONS

Speaker	6.5" full range
Amplifier (watts)	35 watts
Mixer	1 mic, 1 line inputs, CD/MP3 volume control, and tone control, echo time & repeat
Frequency response (-10dB point)	60Hz~18KHz
Indicator	
Battery Low	Red
Charging LED	bi-color, Red: Charging - flash; Green: battery full- steady
Power LED	Blue
Appearance	
Handle	on top
Mount standable	25mm tripod stand socket
Optional components	CD player or Digital voice recorder/player ; Wireless mic (UHF, or Infrared); Rechargeable Battery
Built-In limiter	Yes
Protection circuitry	thermal, subsonic, RF protection, Output DC offset, Power on/off muting and short circuit protection
Power Requirement	Optional rechargeable battery or External power supply 15VDC, 100-240VAC, 50/60Hz
Dimensions (HxWxD)	336 x 220 x 216 mm (13.2" x 8.7" x 8.5")
Weight	Less than 7 kg including battery, CD player

DIMENSIONS

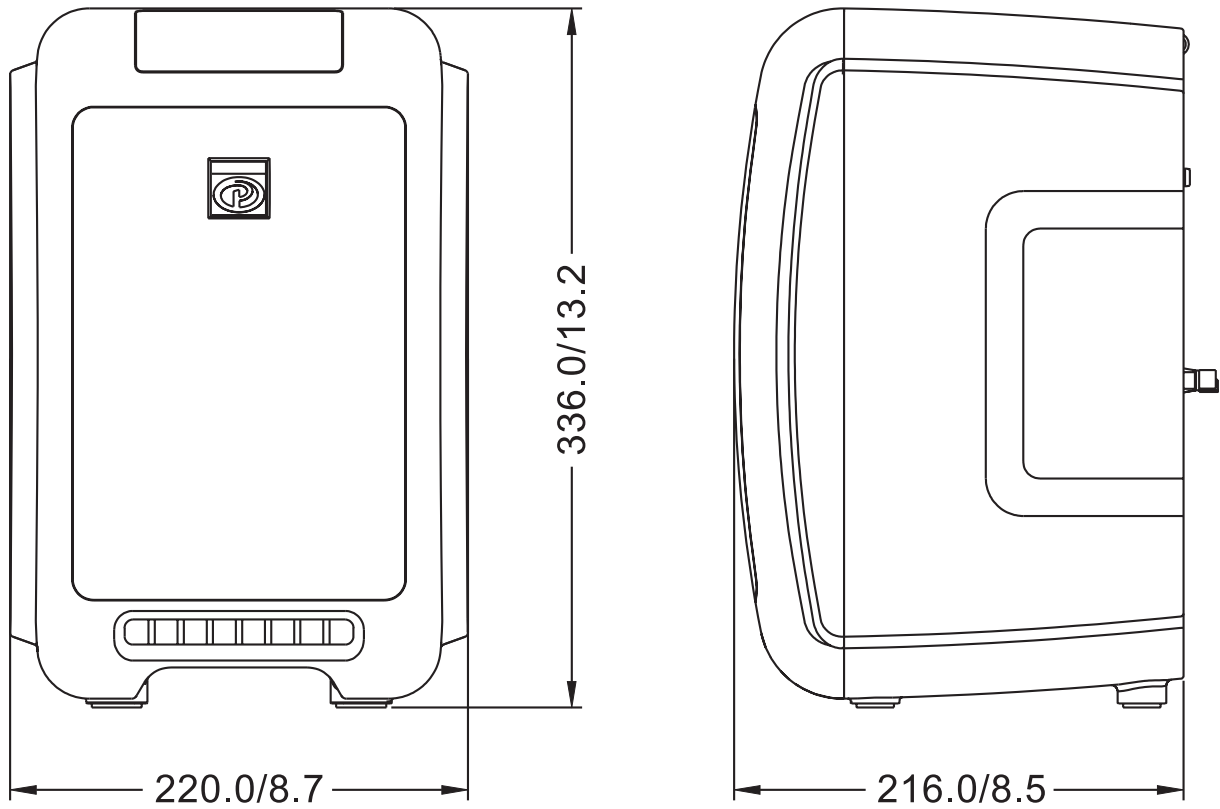

* All measurements are shown in mm/inches.

BLOCK DIAGRAM

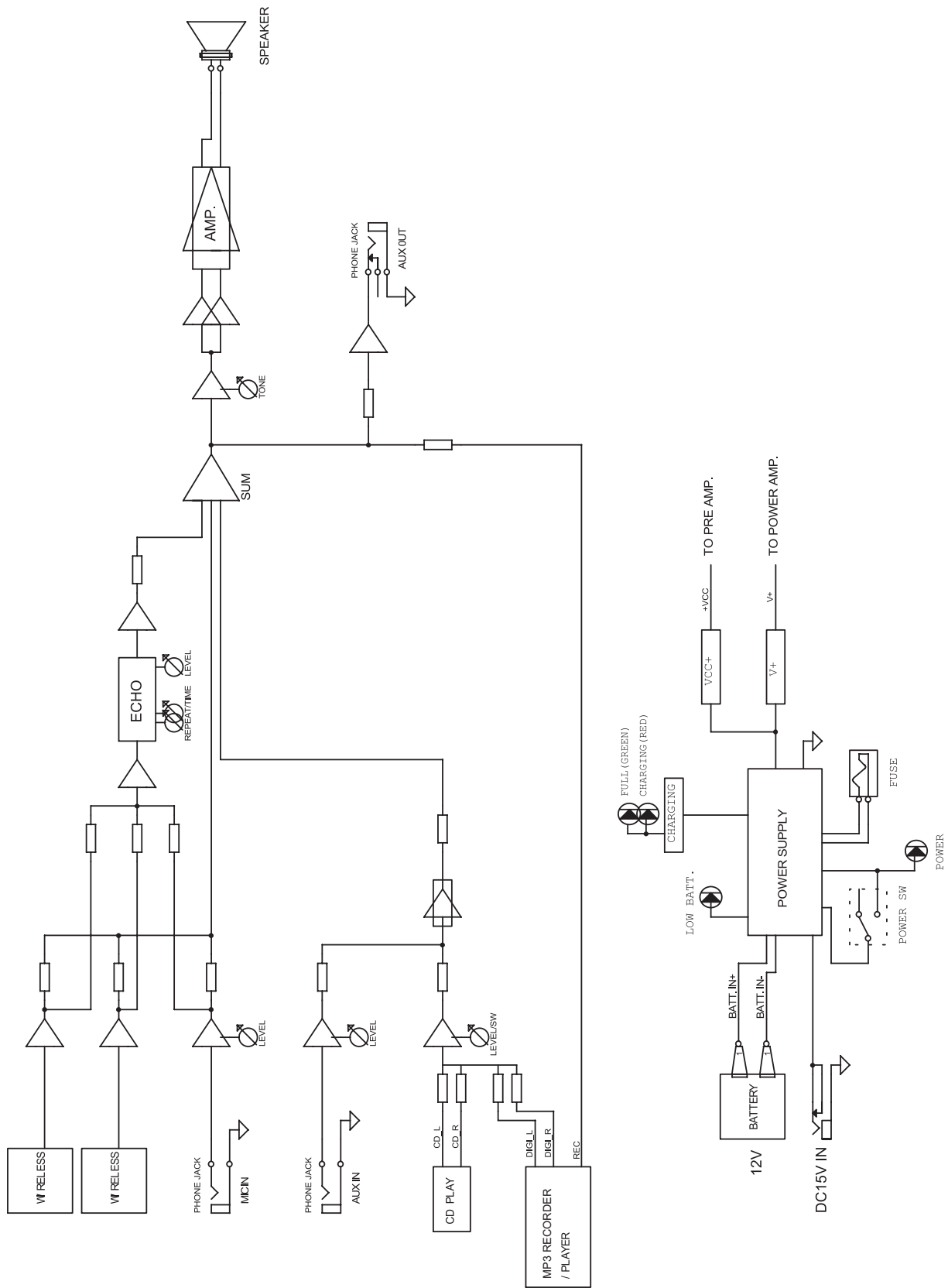

TO PURCHASE ADDITIONAL PHONIC GEAR AND ACCESSORIES

To purchase Phonic gear and optional accessories, contact any authorized Phonic distributor. For a list of Phonic distributors please visit our website at www.phonic.com and click on Get Gear. You may also contact Phonic directly and we will assist you in locating a distributor near you.

SERVICE AND REPAIR

Phonic has over 100 service centers worldwide. For replacement parts, service and repairs please contact the Phonic distributor in your country. Phonic does not release service manuals to consumers, and advice users to not attempt any self repairs, as doing so voids all warranties. You can locate a dealer near you at www.phonic.com.

WARRANTY INFORMATION

Phonic stands behind every product we make with a no-hassles warranty. Warranty coverage may be extended, depending on your region. Phonic Corporation warrants this product for a minimum of one year from the original date of purchase against defects in material and workmanship under use as instructed by the user's manual. Phonic, at its option, shall repair or replace the defective unit covered by this warranty. Please retain the dated sales receipt as evidence of the date of purchase. You will need it for any warranty service. No returns or repairs will be accepted without a proper RMA number (return merchandise authorization). In order to keep this warranty in effect, the product must have been handled and used as prescribed in the instructions accompanying this warranty. Any tempering of the product or attempts of self repair voids all warranty. This warranty does not cover any damage due to accident, misuse, abuse, or negligence. This warranty is valid only if the product was purchased new from an authorized Phonic dealer/distributor. For complete warranty policy information, please visit <http://www.phonic.com>.

CUSTOMER SERVICE AND TECHNICAL SUPPORT

We encourage you to visit our online help at <http://www.phonic.com/help/>. There you can find answers to frequently asked questions, tech tips, driver downloads, returns instruction and other helpful information. We make every effort to answer your questions within one business day.

**Phonic America Corporation
6103 Johns Road #7
Tampa, FL 33634
(813) 890-8872
support@phonic.com
<http://www.phonic.com>**

PHONIC

PHONIC
WWW.PHONIC.COM